

# YOUNG

Un classico delle porte a battente Novellini

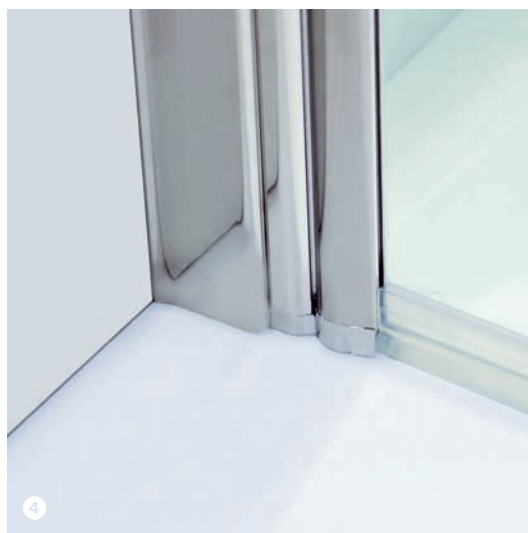
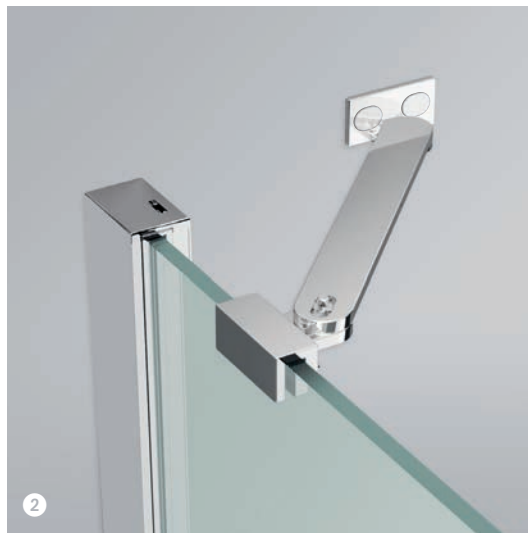
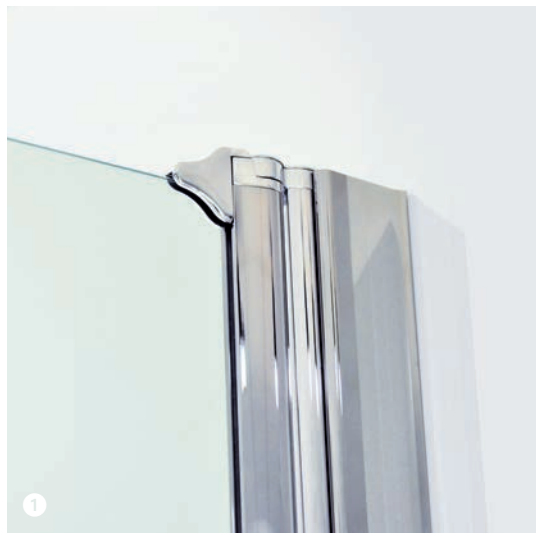

- 1 Cerniera in apertura a 90°/180°. 2 Barra di sostegno orientabile a 45°.  
3 Maniglia in metallo cromato. 4 Guarnizioni inferiori per installazione a filo bordo interno del piatto.

## TRATTAMENTI



**TRATTAMENTO ANTIGOCCIA**  
Cristalli sempre brillanti, facili da pulire. Impedisce la formazione del calcare e dei batteri.  
**Solo su vetri trasparenti.**



**FINITURA CROMO PVD**  
Ciclo di produzione integrata a zero emissioni, 100% ecologico. Anticalcare, resistente all'azione batterica, ecologica brillantezza resistente nel tempo.





190 cm



6 mm



3 cm



p. 107

BOX DOCCIA AD ANGOLO,  
APERTURA 2 ANTE A BATTENTE E 2 FISSE

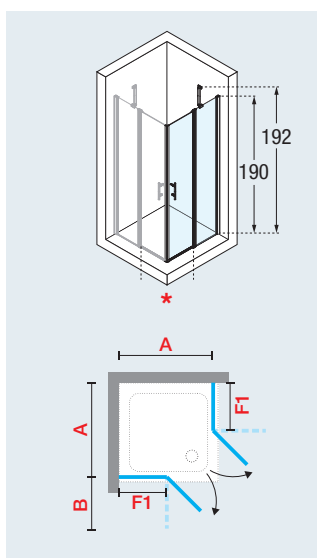

PER COMPORRE UN ANGOLO ORDINARE 2 LATI

Misure				Codice	Scelta Vetro			Scelta Profilo / Prezzo		
Misura effettiva d'ingombro		Entrata	Ingombro anta esterno		1	2	4	A	B	K
<b>A</b>	<b>F1</b>	<b>*</b>	<b>B</b>		Trasparente	Aqua	Satin	Bianco	Silver	Cromo
69 - 72	32	47	34	<b>YOUNG A 66 L-</b>						
72 - 75	32	51	37	<b>YOUNG A 69 L-</b>						
75 - 78	32	55	40	<b>YOUNG A 72 L-</b>						
78 - 81	32	60	43	<b>YOUNG A 75 L-</b>						
81 - 84	42	50	36	<b>YOUNG A 78 L-</b>						
84 - 87	42	54	39	<b>YOUNG A 81 L-</b>						
87 - 90	42	58	42	<b>YOUNG A 84 L-</b>						
90 - 93	42	62	45	<b>YOUNG A 87 L-</b>						
93 - 96	42	67	48	<b>YOUNG A 90 L-</b>						
96 - 99	42	71	51	<b>YOUNG A 93 L-</b>						

ESEMPIO COMPILAZIONE CODICE:

YOUNGA66L-1A

=

YOUNGA66L-

+

1

+

A



Profilo Di Contenimento

Finitura	Codice	Prezzo
Bianco	<b>R55BOA01-A</b>	
Silver	<b>R55BOA01-B</b>	
Cromo	<b>R55BOA01-K</b>	

**NB: Rilevare le misure da muro a bordo interno del piatto doccia.**

## DATI TECNICI

### VETRO TEMPRATO 6 mm (European standards UNI EN 14428)

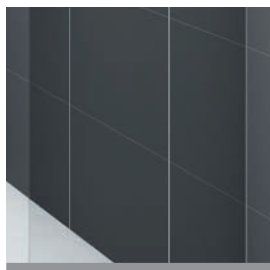

trasparente  
COD. 1

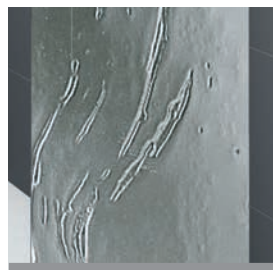

aqua  
COD. 2



satin  
COD. 4

### FINITURA PROFILI



bianco  
COD. A

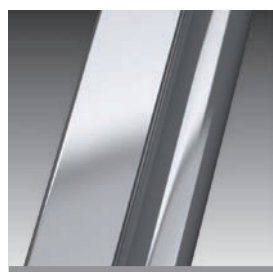

silver  
COD. B



cromo  
COD. K



### MANIGLIA



maniglia in metallo  
cromato  
interasse 140mm

Per informazioni  
altre maniglie  
vedi pag. 318

### OPTIONAL



Barra di sostegno ad angolo

Misure	Codice	Prezzo
15 cm	<b>R80LOU150-K</b>	
25 cm	<b>R80LOU250-K</b>	
35 cm	<b>R80LOU350-K</b>	
45 cm	<b>R80LOU450-K</b>	



Barra di sostegno 150 cm  
in dotazione solo con Young F

Finitura	Codice	Prezzo
bianco	<b>R80LUH15-A</b>	
silver	<b>R80LUH15-B</b>	
cromo	<b>R80LUH15-K</b>	

### COME RILEVARE LE MISURE

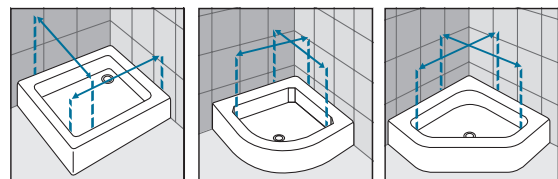

Rilevare le misure da muro a bordo interno del piatto doccia. Le misure devono essere rilevate sulla parete finita, a rivestimenti posati, secondo gli schemi riportati.

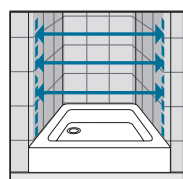

Rilevare le misure da muro a muro, in basso, in alto, al centro e utilizzare quella di valore inferiore. Le misure devono essere rilevate sulla parete finita, a rivestimenti posati, secondo gli schemi riportati.

### MISURE DI INGOMBRO PROFILI DI FISSAGGIO

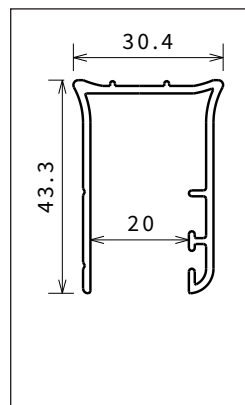

a muro

COD. P01YOUST-A  
P01YOUST-B  
P01YOUST-K

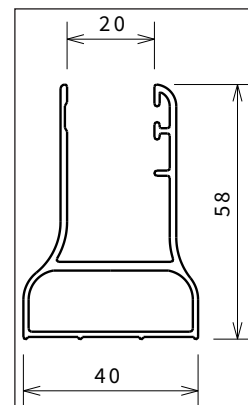

compensativi

COD. P04YOUST-A  
P04YOUST-B  
P04YOUST-K

Per ulteriori  
informazioni  
sui profili,  
vedi pag. 332